

Article number: 01010301  
 Description: Retaining ring A 14 DIN 471  
 Stainless 411  
 Note: Fitted with ZGA pilers

## Measures

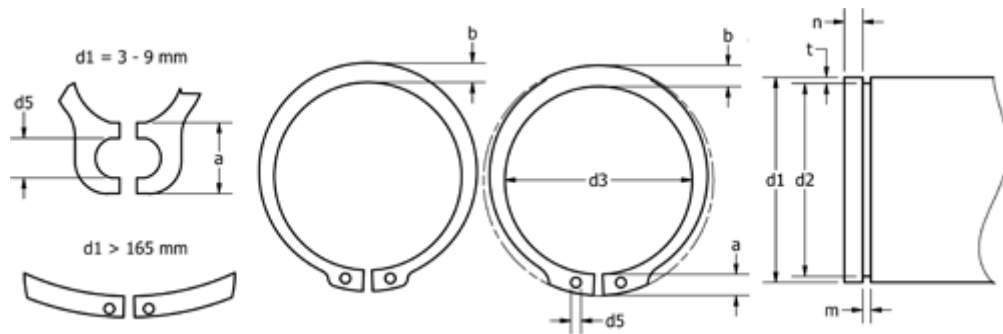

a max	= 3.5	FN kN	= 2.1	s	= 1.00
AN mm <sup>2</sup>	= 12.9	FRg kN	= 2.40	t	= 0.30
b	= 2.1	FR kN	= 6.40	tol	= -0.11
d1	= 14	g	= 1.0	tol	= -0.06
d2	= 13.4	K kN-mm	= 22.90	tol	= +0,10-0,36
d3	= 12.9	m min	= 1.10	Tong	= ZGA-1
d5 min	= 1.7	n abl x 1000	= 58.0	Weight kg/1000	= 0.640
Description	= A14	Nominal drive	= 0.9		